

Bottom View 1:5

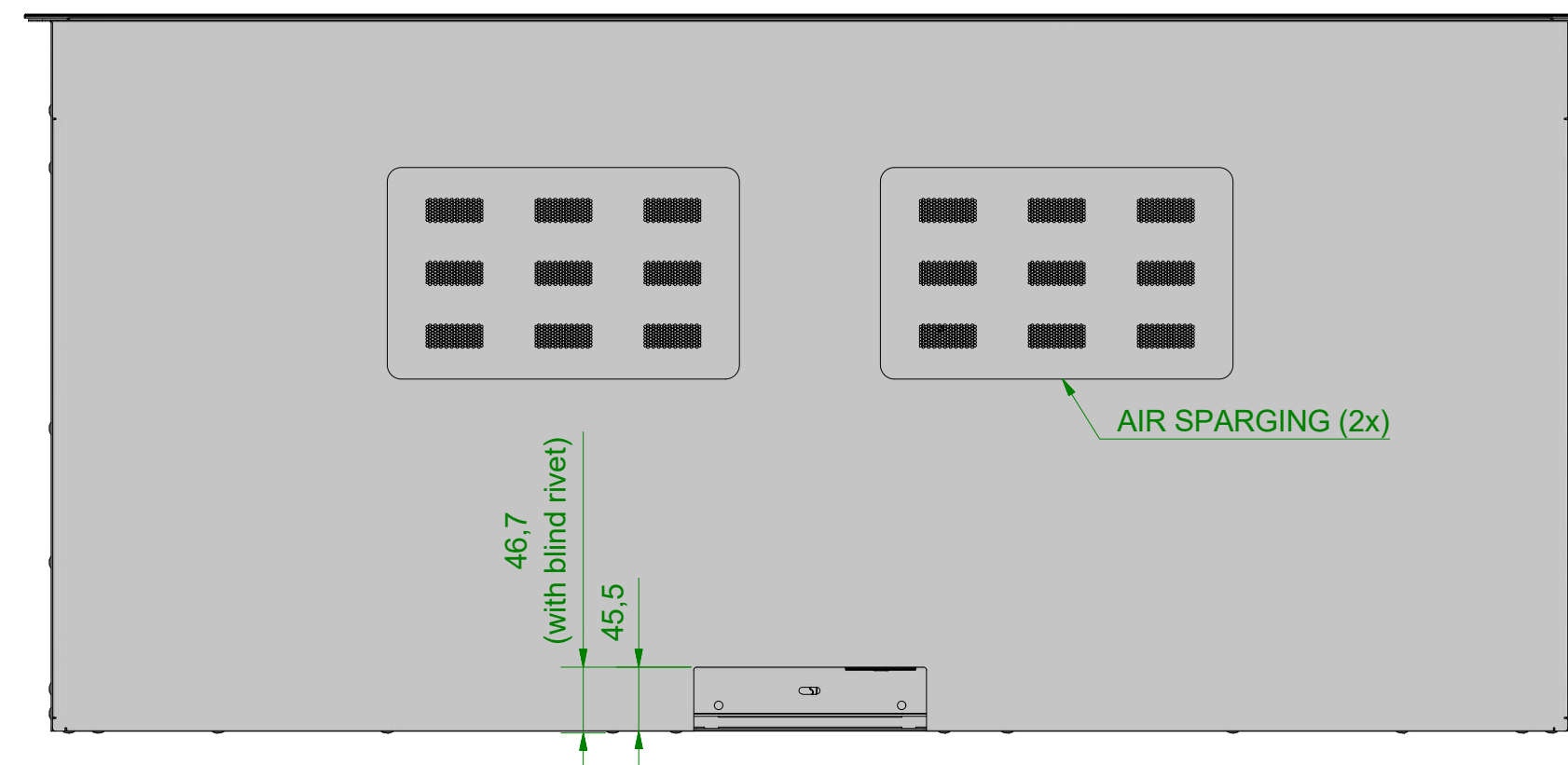

A 1:2

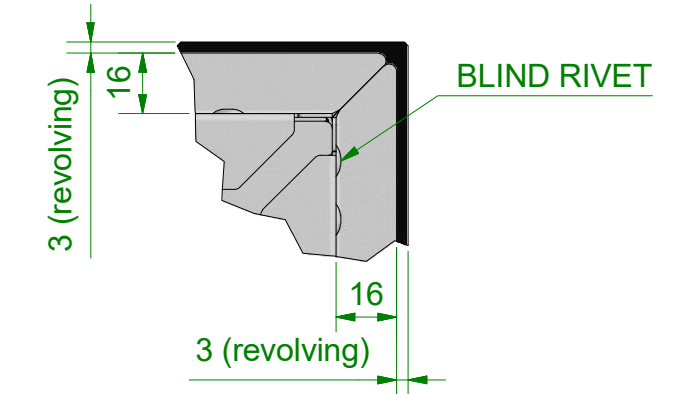

Righthand View 1:5

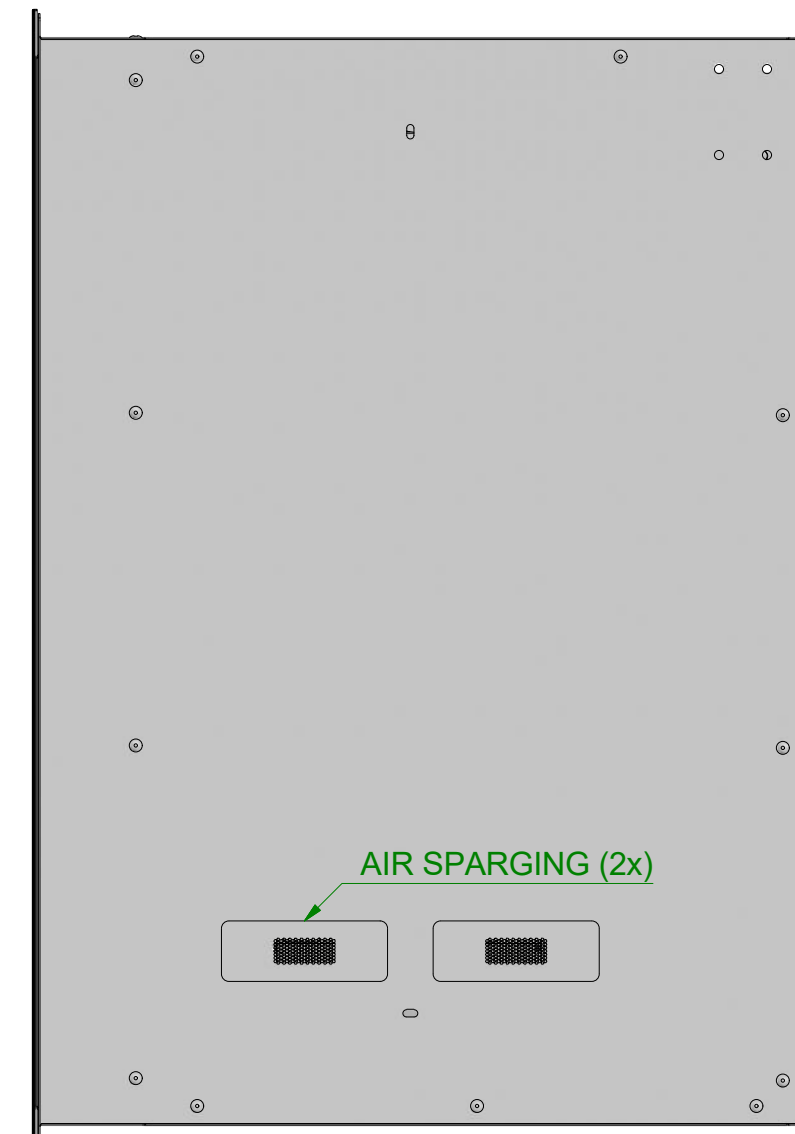

Front View 1:5

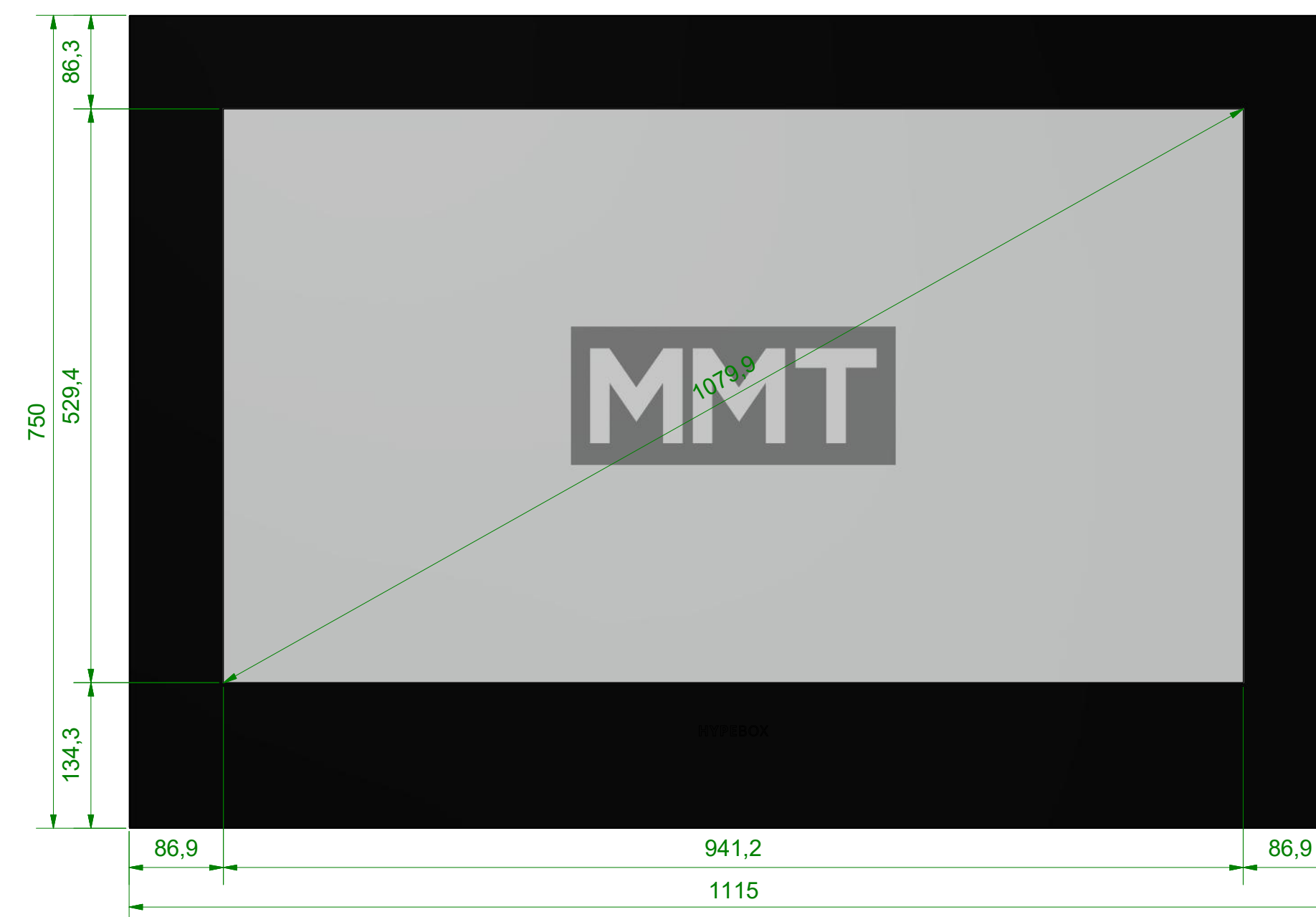

Lefthand View 1:5

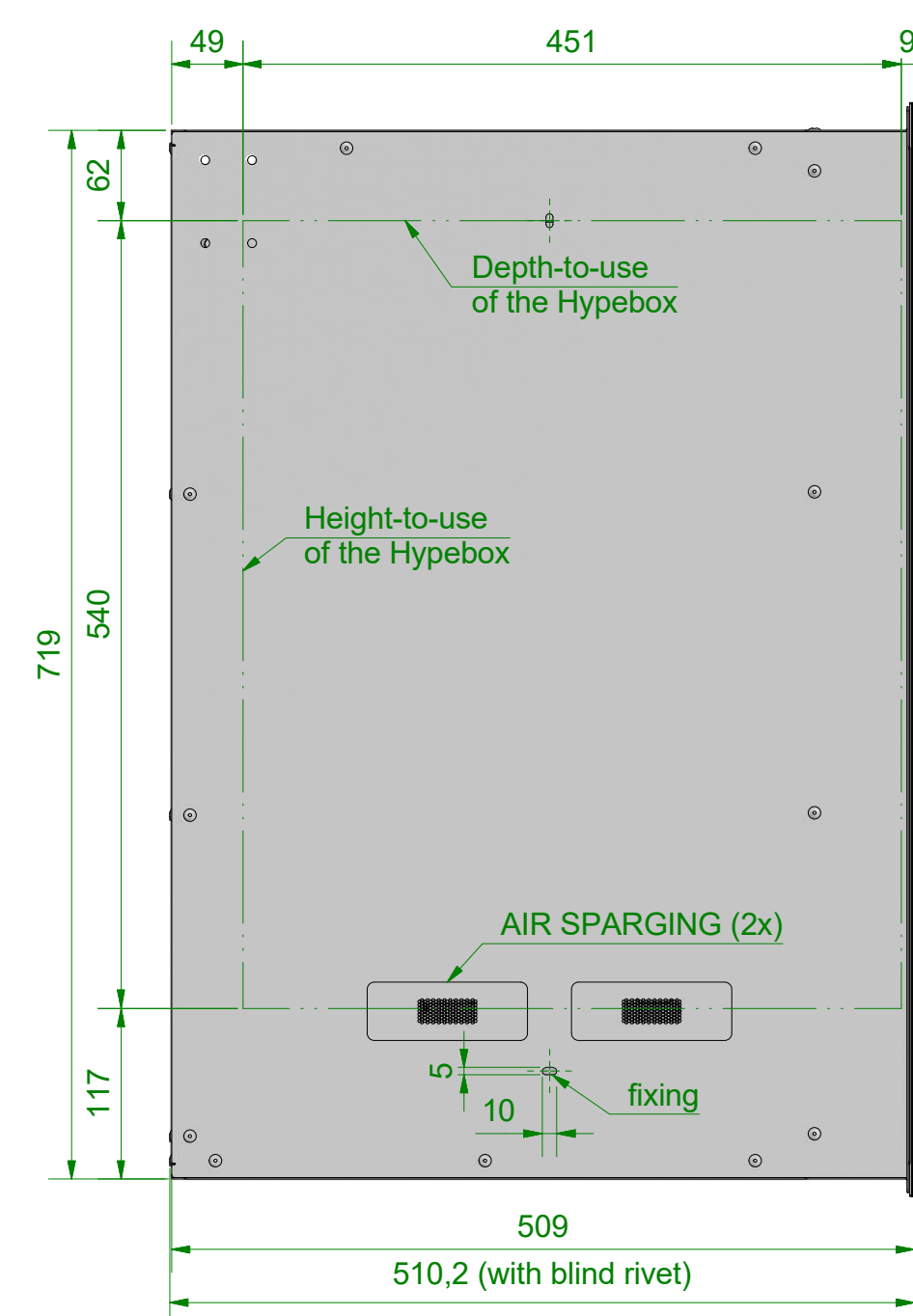

Lefthand View 1:5
(DRAWER OPEN)

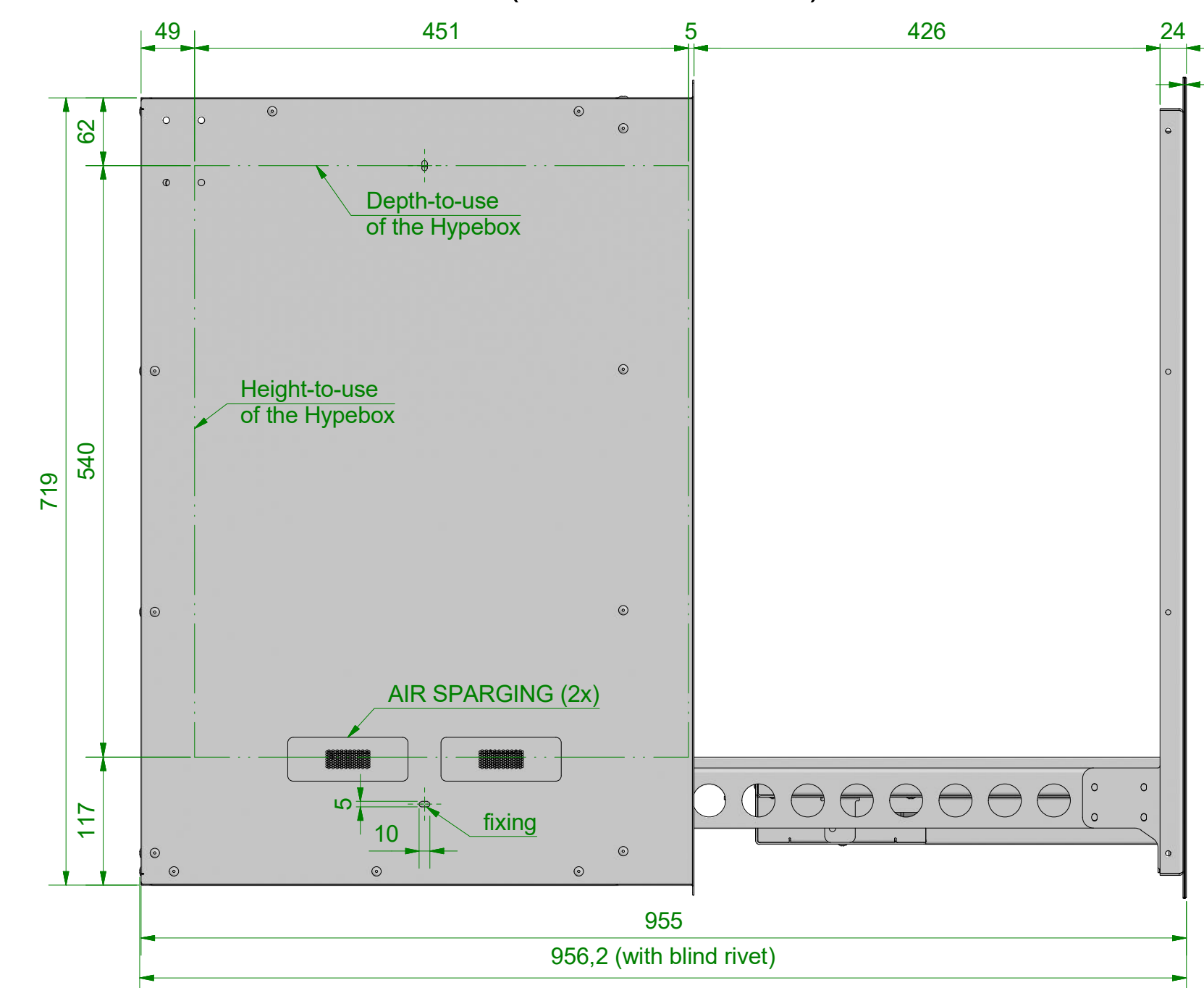

Back View 1:5

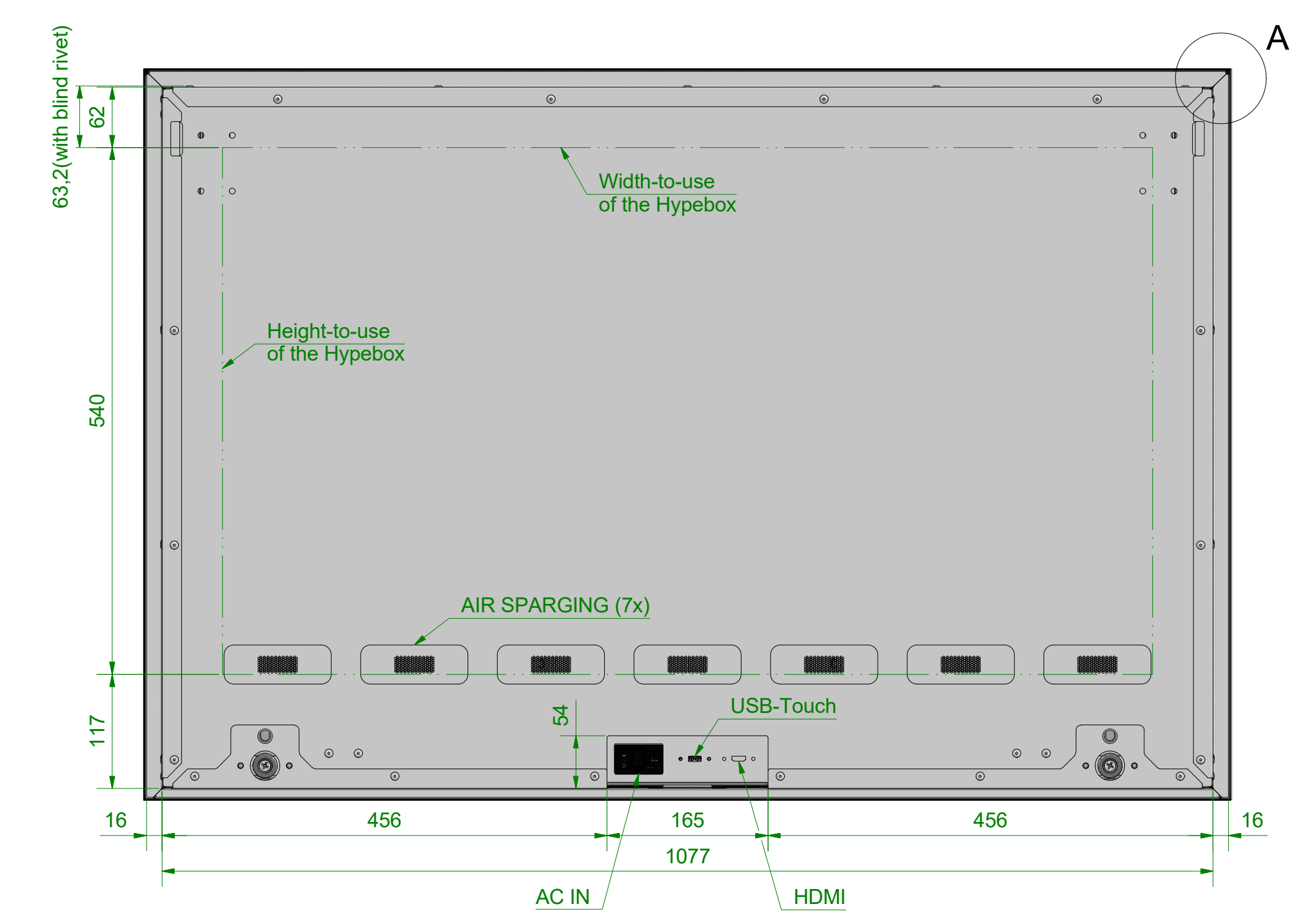

Isometric View 1:10

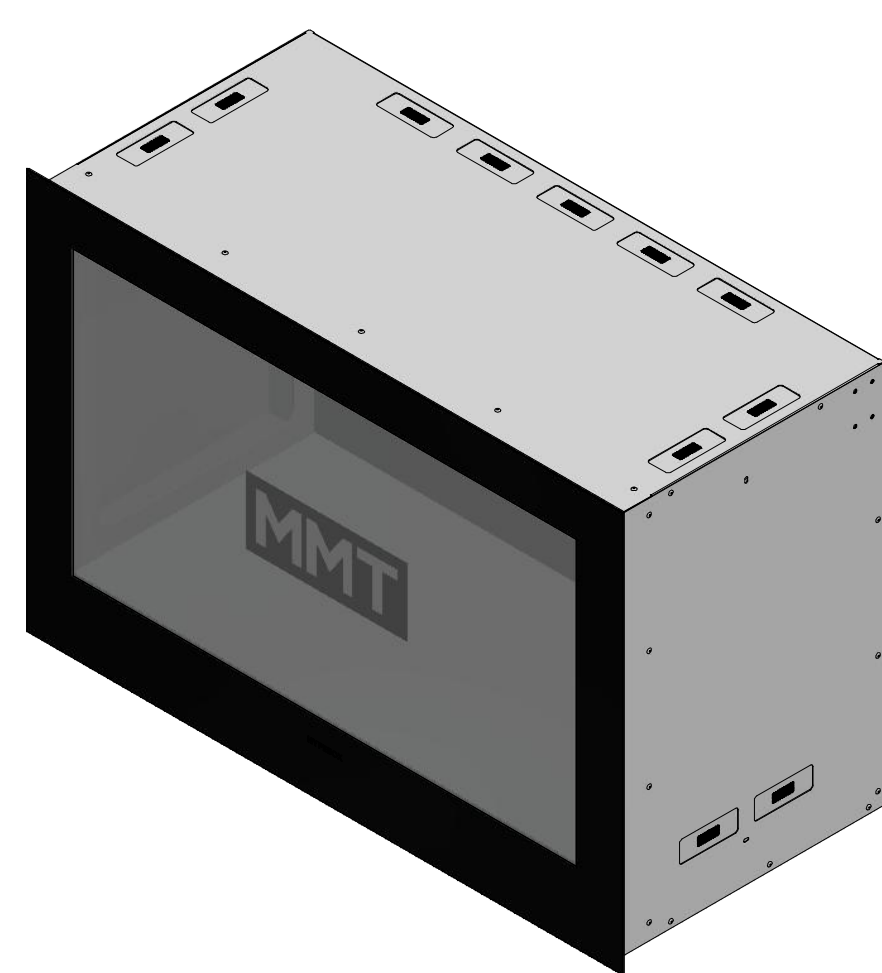

Top View 1:5

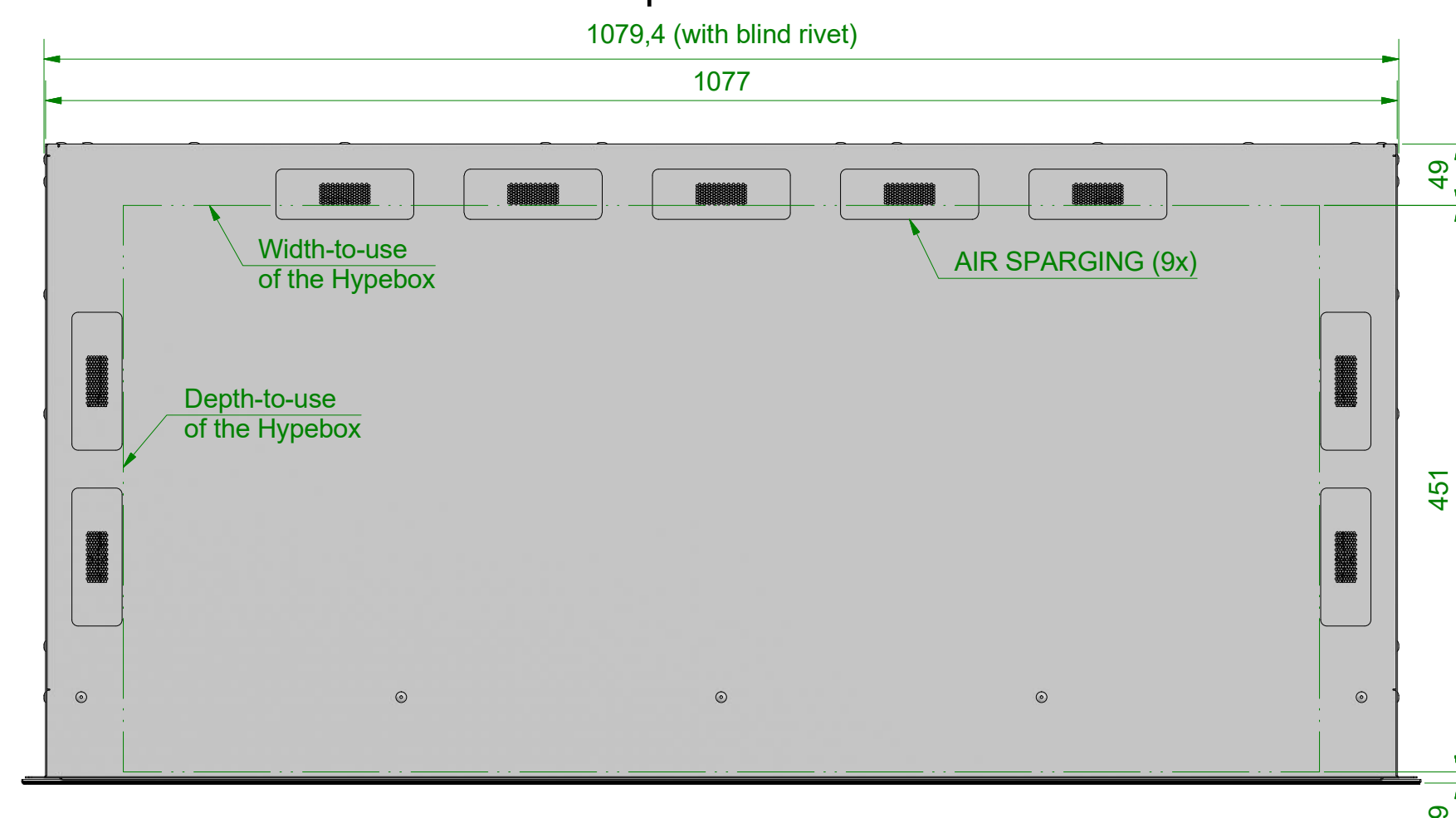

size (inch)		product / model		MMT GmbH & Co. KG		www.mmt.io	
43"		Hypebox/HBT43L-IW					
drawing no.		version		revision			
Hypebox HBT43L-IW		V1.0					
The copying, distribution and utilization of this document as well as the communication of its contents to others without expressed authorization is prohibited. Offenders will be held liable for the payment of damages. All rights reserved in the event of the grant of a patent, utility model or ornamental design registration. (DIN 34)				designed by		checked by	
				D. Lange		D. Lange	
				approved on		released on	
				19.04.2017		12.01.2018	
technical specifications				weight		sheet	
DIN ISO 2768 - m				0 kg		1:5 A0 1/1	
DIN ISO 2768 - k				DIN EN ISO 9013 - 1		DIN EN ISO 15000 - 8	