

Bottom View
1:5

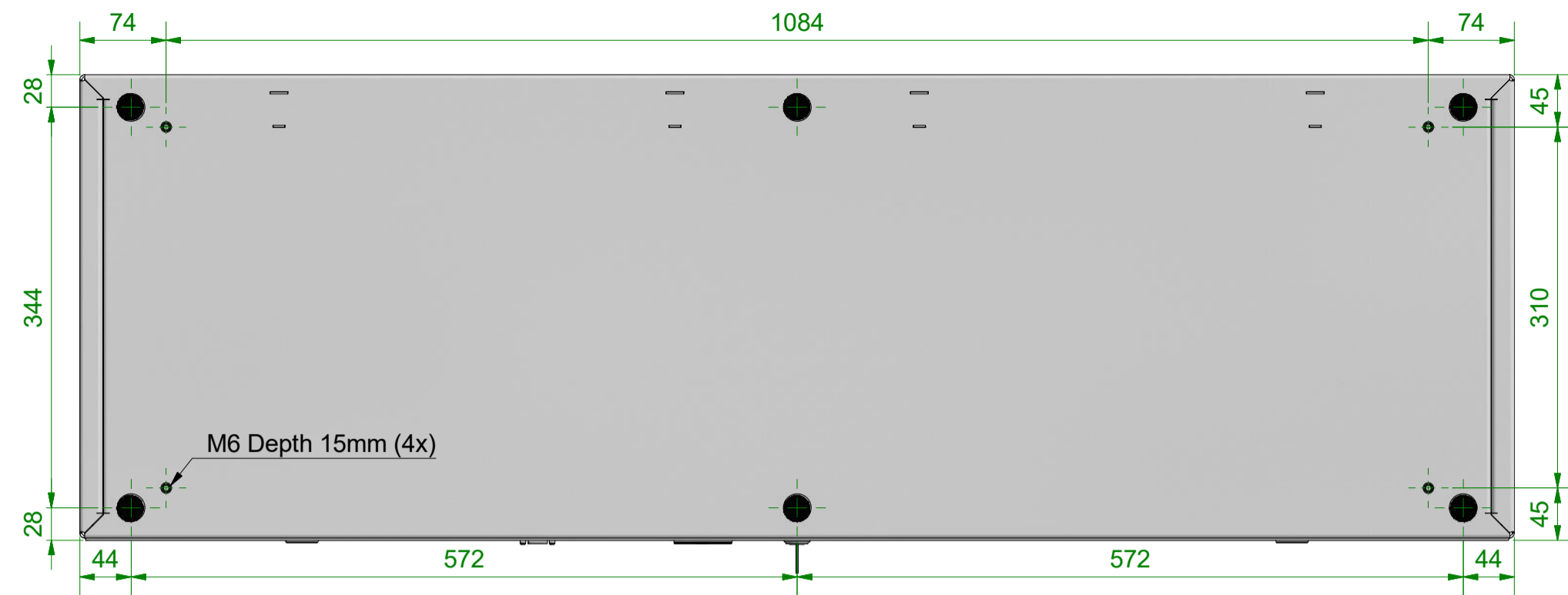

Righthand View
1:5

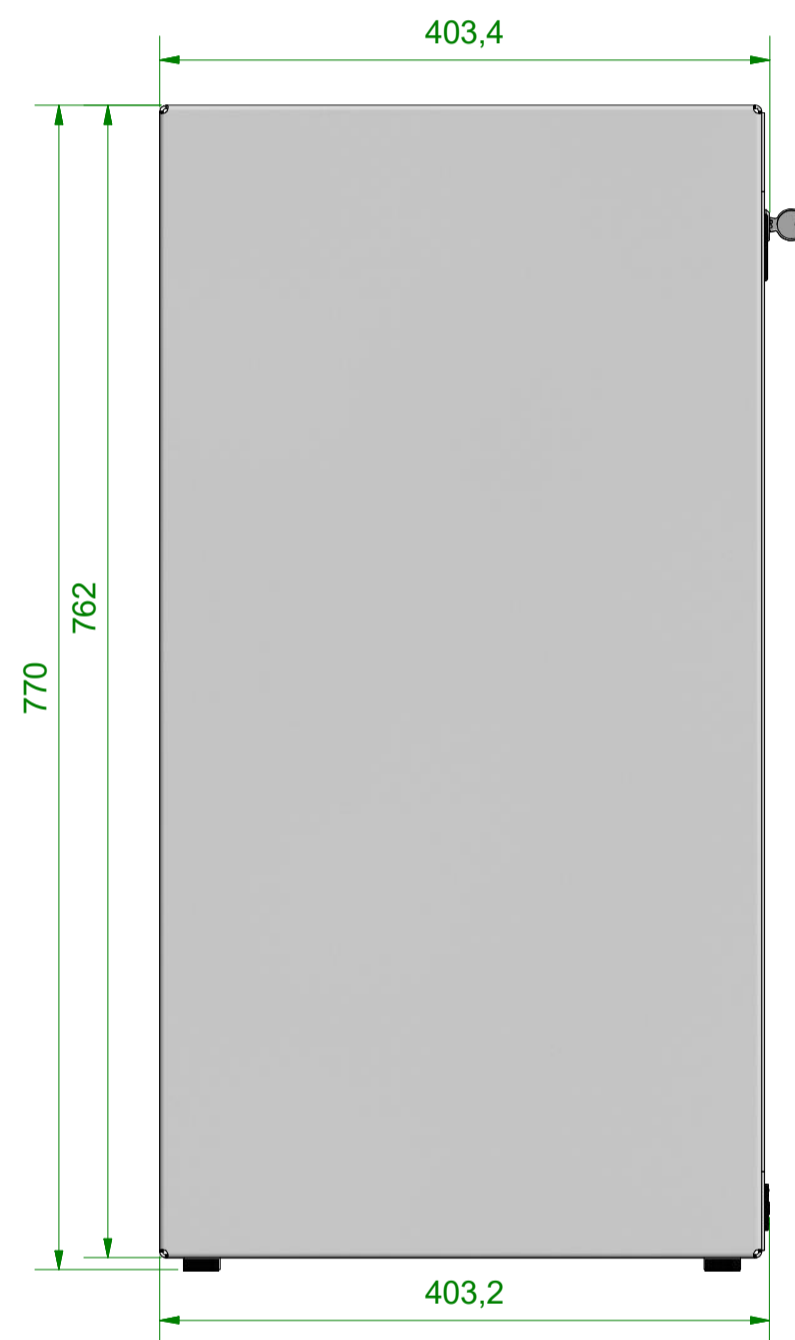

Front View
1:5

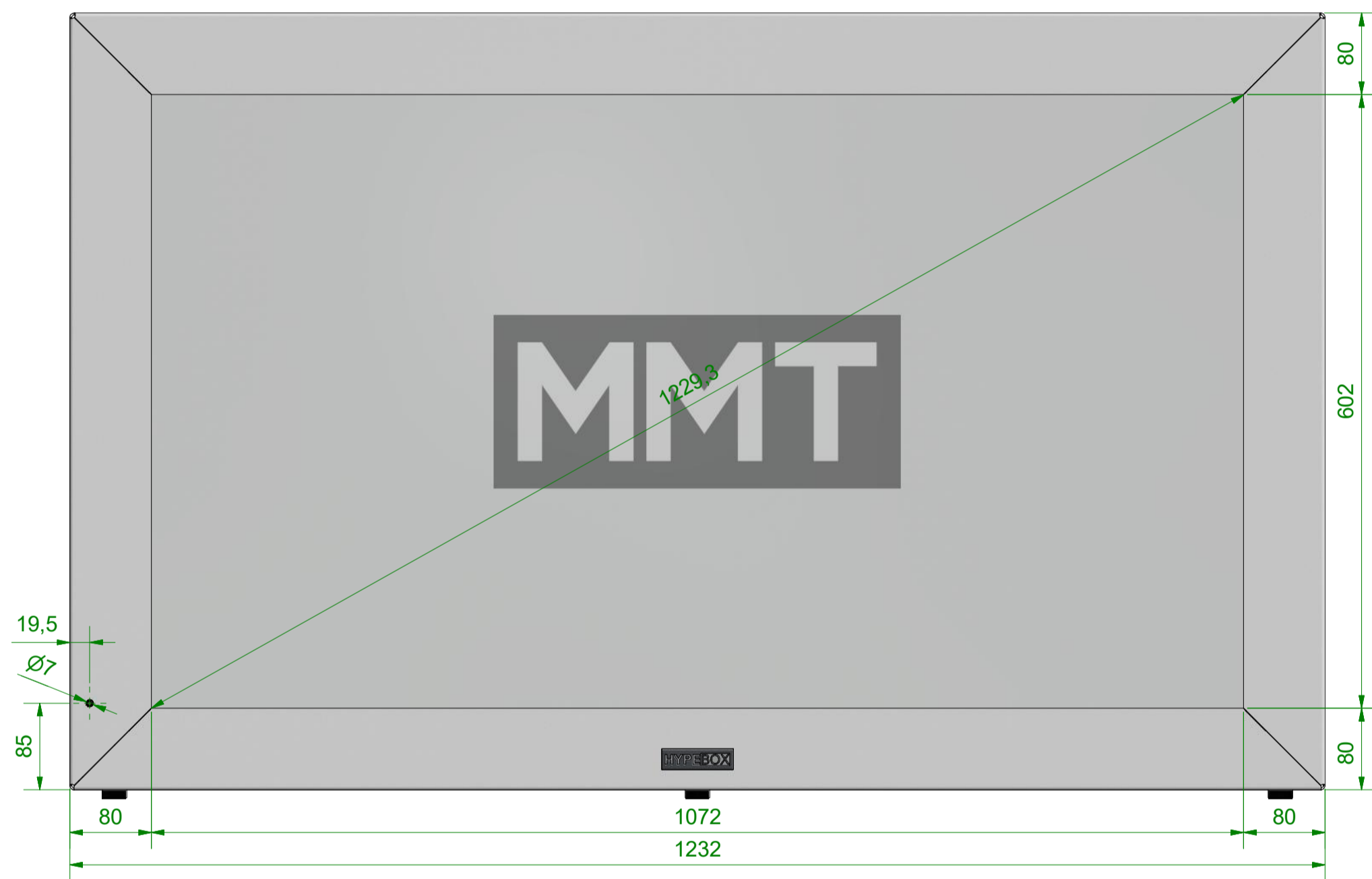

Lefthand View
1:5

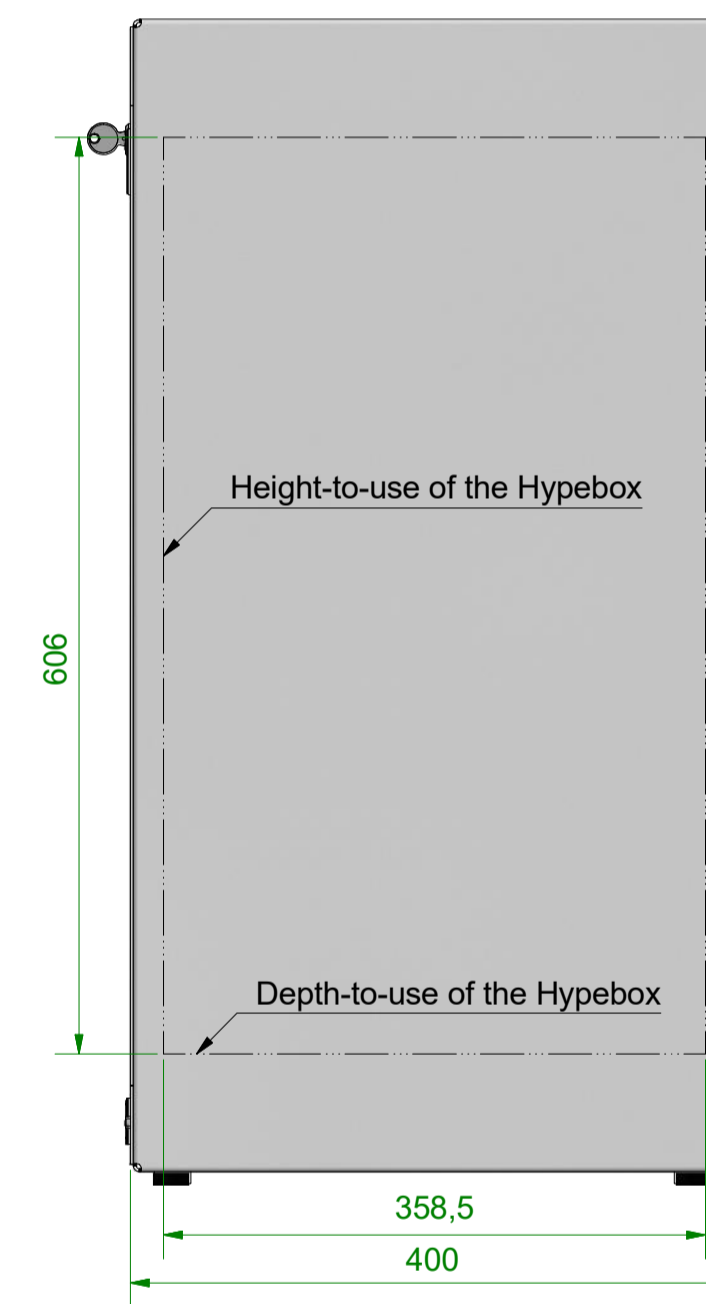

Back View
1:5

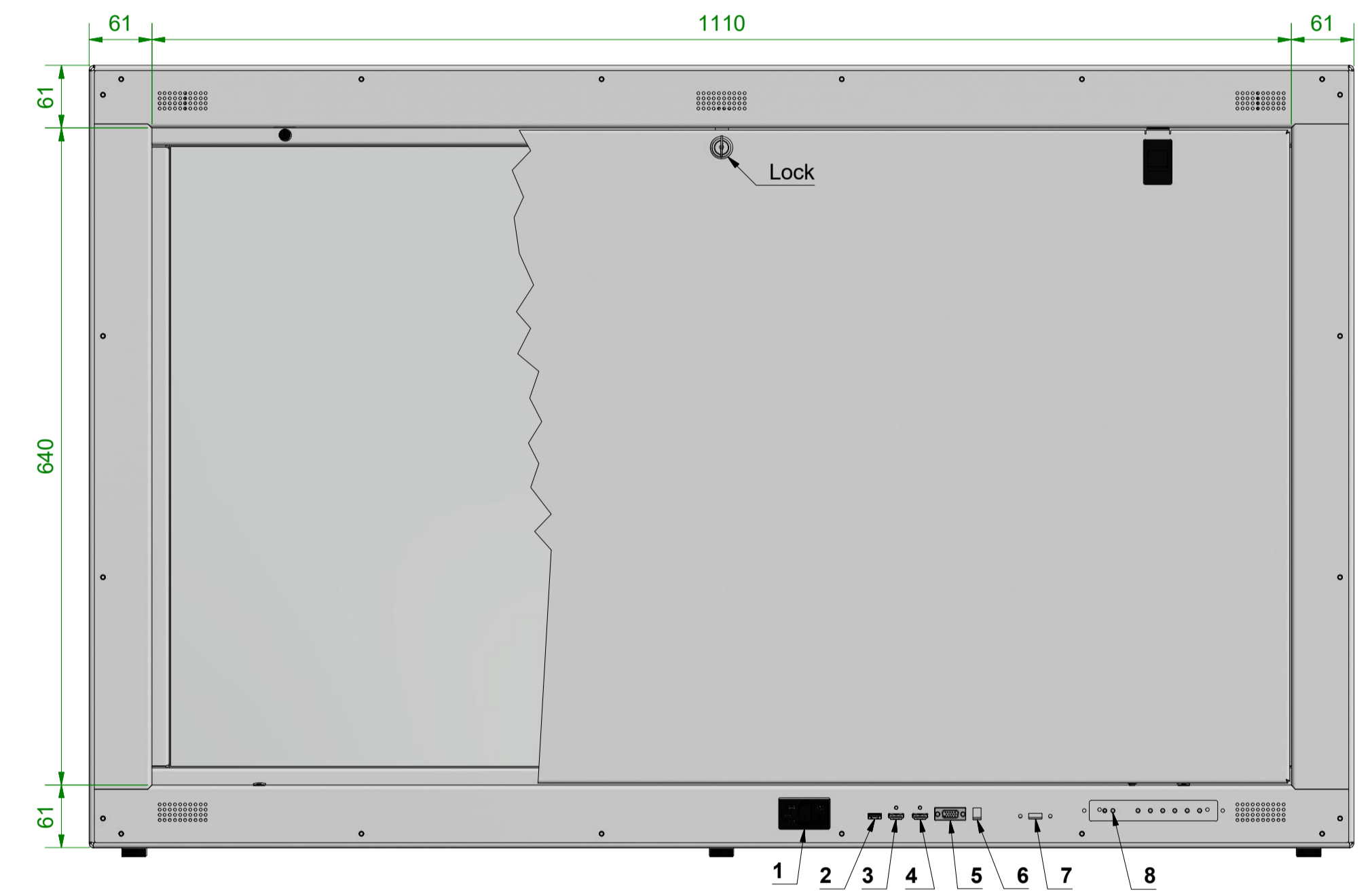

Top View
1:5

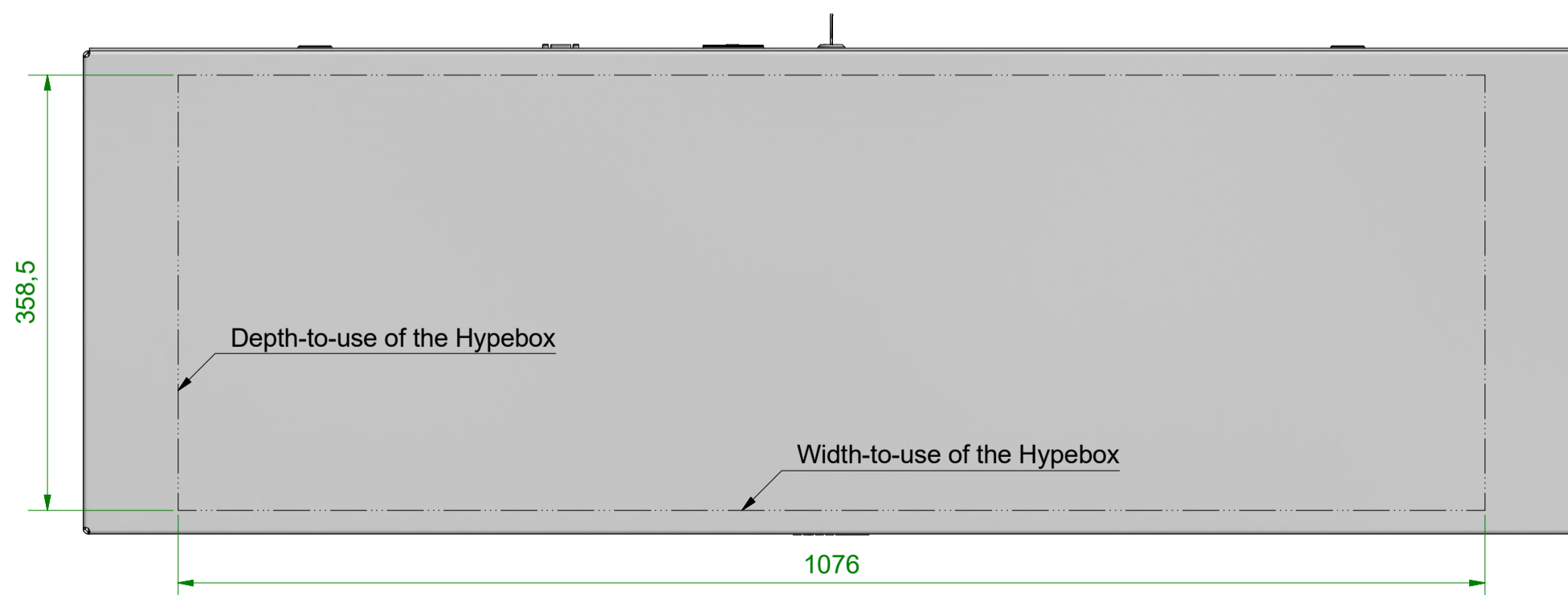

Isometric View
1:10

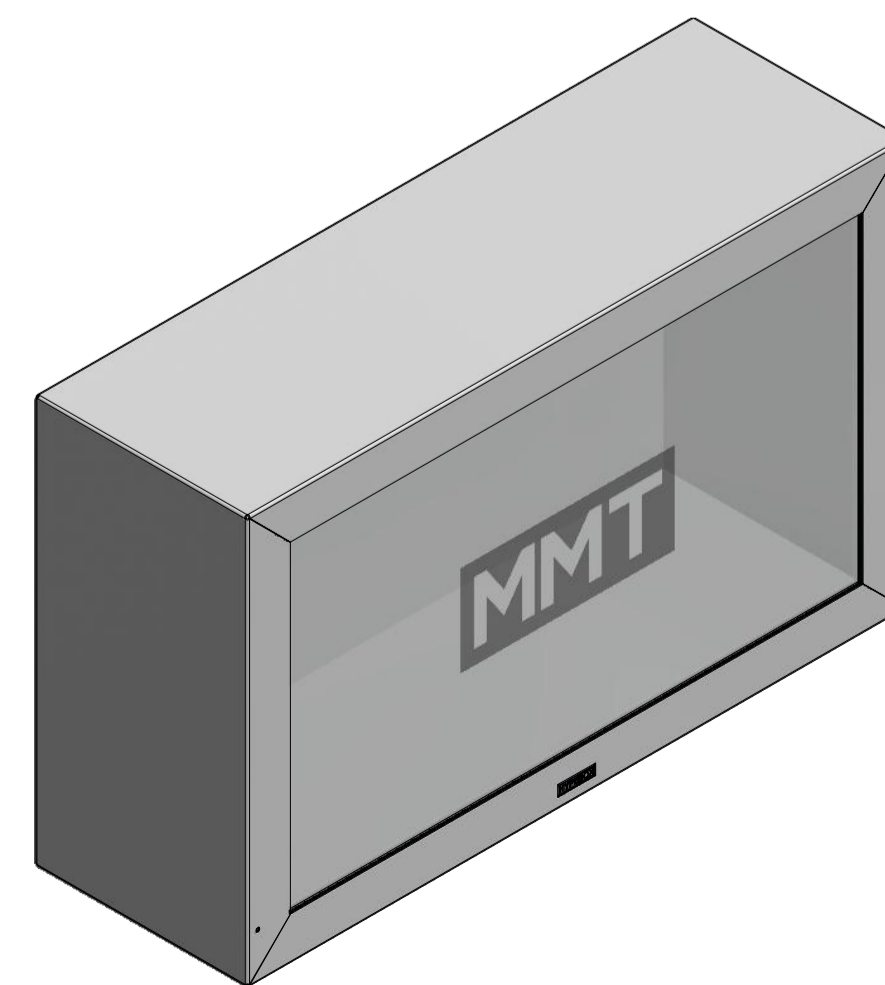

item	designation
1	PEM C14 (Power Input)
2	USB
3	HDMI 1
4	HDMI 2
5	VGA
6	Audio In
7	USB Touch
8	Control Keys

size (inch): 49"	product / model: Hypebox/HBT49L	MMT www.mmt.io
drawing no.: Hypebox HBT49L G5	version: revision: V1.0	
<small>contracted by: D. Lange drawn by: D. Lange checked by: D. Lange</small>		<small>constructed on: 16.04.2018 drawn on: 17.04.2018 checked on: 17.04.2018</small>
<small>measures without tolerances: machined: DIN ISO 2768 - m non-machined: DIN ISO 2768 - K thermal cut: DIN EN ISO 9013 - 1 welded: DIN EN ISO 13920 - B</small>		<small>weight: 35 kg scale: 1:20 format: A1 sheet: 1 / 1</small>